



SUSTAINABLE WATER MANAGEMENT SOLUTIONS
PRODUCT AND APPLICATION GUIDE

CAPTURE > FILTER > REUSE





SUSTAINABLE WATER MANAGEMENT SOLUTIONS

WHY RAINWATER HARVEST?

 The RainXchange™ System is a sustainable solution for Water Conservation and Stormwater Management

WATER CONSERVATION

- At least 36 states expect to face water shortages within the next 5 years according to the U.S. Government Accountability Office.
- Capturing and reusing rainwater reduces the community's demand on the municipal water supply, reduces the owner's water bills and helps avoid strict water schedules.

STORMWATER MANAGEMENT

- According to the EPA, stormwater runoff is one of the main reasons 40% of our lakes, rivers, and estuaries are not clean enough for fishing or swimming.
- Rainwater harvesting is a solution for managing stormwater runoff and decrease flooding.
- Federal, state and local regulations are requiring stormwater to be managed at the source. The RainXchange™ System provides a solution to help meet these governmental regulations.



DID YOU KNOW?

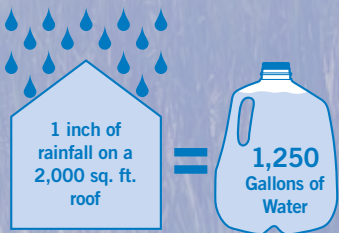

- This roof in a region receiving 30 inches of annual rainfall generates 37,500 gallons of reusable water.
- Capturing this water reduces run-off and flooding, as well as provides a significant amount of water for reuse.
- The RainXchange™ System allows you to collect thousands of gallons of water anywhere, even in the desert!

HOW CAN YOU USE THE RAINXCHANGE™ SYSTEM?



Landscape irrigation for your lawn and flowerbeds



Manage stormwater and decrease flooding



Topping off water features, swimming pools & hot tubs



Washing your car, patio or deck



Toilet and laundry water supply

WOULD YOU
RATHER
HAVE THIS

OR

THIS?

Traditional ways of rainwater harvesting do not add beauty or value to your home or office setting.

RainXchange™ by Aquascape Inc. adds the beauty of a water feature to a revolutionary system for capturing and reusing our most precious resource, water.

THE RAINXCHANGE™ SYSTEM IS REVOLUTIONARY!

The RainXchange™ System by Aquascape is a revolutionary design that combines a recirculating decorative water feature with a sub-surface rainwater harvest storage system.

- **Clean, Filtered Water Storage** – While you enjoy the benefits of a decorative water feature, the RainXchange™ System filters the stored water providing access to clean, clear, usable water.
- The RainXchange™ System reveals only a **beautiful water feature** that integrates easily into existing landscapes.
- Locating and **storing water underground** maintains the integrity and beauty of your home and landscape.



- **Wildlife Habitat**
A small portion of the stored water is brought to the surface for aeration and allows the water to become available for wildlife interaction.
- **Water Feature Lifestyle**
Enhanced landscaping improves property value and water features provide soothing sights and sounds that help you relax and de-stress in today's busy world.
- **Environmental Conservation**
Capturing rainwater to operate the water feature creates true self-sustainability, drastically reducing the need for traditional water sources.



RainXchange™

Rainwater Harvest Systems

By Aquascape, Inc.

The RainXchange™ System is a sustainable **stormwater management** solution for both commercial and residential applications. The modular design of the RainXchange™ System provides the flexibility to construct a rainwater collection system based on your application's requirements. The unique integration of a water feature provides filtration as well as enhances the overall landscape design.



OVERFLOW MANAGEMENT

- Excess stormwater can be managed through infiltration, rain gardens, surface run-off, or into the local stormwater system.



RECIRCULATING FILTER SYSTEM

- Snorkel® Vault and Centipede® Module optimize water utilization and recirculation within the system.
- Snorkel® Vault and Centipede® Module provide convenient access point for inspection and maintenance.
- High efficiency/low energy consuming submersible pump recirculates the water.
- Beneficial bacteria and enzymes reduce organic wastes and pollutants to less toxic substances that can be absorbed by plants, creating a perfect cycle of nutrient reuse.



HIGH PRESSURE PUMP

- A high pressure pump is connected to the system to provide access to the stored water.



PERMEABLE PAVERS

- The RainXchange™ System can be used underneath permeable pavers as a means of capturing stormwater.
- A liner membrane beneath the permeable pavers collects the water and directs it towards the storage basin.
- Water features can be incorporated directly on top of the permeable pavers providing a truly unique design element.



IRRIGATION SYSTEM

- The RainXchange™ System can be used for simple hand-watering or combined with a professional irrigation system.



MODULAR STORAGE RESERVOIR

- Engineered plastic AquaBlox® create the structure of the storage basin.
- Modular design of the AquaBlox® and flexible waterproof liner allow the storage basin to be configured to fit a wide variety of applications.
- AquaBlox® are assembled on-site making shipping and handling extremely efficient.
- Durable EPDM waterproof liner surrounds the AquaBlox® creating a water-tight storage basin.



DOWNSPOUT FILTER

- Captures and removes pollutants and debris flushed into the system during a rain event.
- Coarse filter screen removes leaves, twigs, and seeds.
- Smaller suspended particles are captured in a fine mesh which can easily be removed for cleaning.
- Multiple Downspout Filters can be utilized to capture more water.

GREEN BUILDING APPLICATIONS

Architects, Builders, Developers, Land Planners, the RainXchange™ System is an ideal solution for your next green building project. Most residential and commercial developments require some degree of an effective storm water management strategy. This creates an amazing opportunity to not only store excess water, but to cherish its presence by understanding it and turning it into an asset of the design, as opposed to an afterthought. The water feature then becomes a destination point for a family or an outdoor classroom for children.

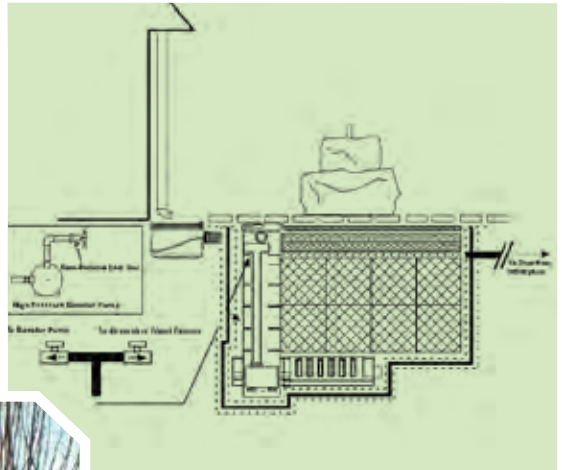

1. Excavation of site. RainXchange™ modular storage reservoir will be placed underneath a permeable patio.
2. The entire base of the patio is lined with an impermeable membrane to capture the water and direct it towards the water storage reservoir. 96 AquaBlox® tanks are positioned inside a 9 ft. x 11 ft. x 6 ft. deep basin creating 3,000 gallons of water storage capacity.
3. A water permeable woven geotextile underlayment fabric covers the top of the AquaBlox® tanks providing a permeable base for the gravel and screening to be spread over the storage reservoir.
4. Overhead view of the completed project. Note the fountain rock positioned directly above the AquaBlox® area.

CREATING OPPORTUNITIES WITH STORMWATER

Impermeable surfaces, such as roofs, roads, driveways, patios and sidewalks create a significant amount of stormwater run-off during rain events. Strict regulations require developers and engineers to properly manage the stormwater on any new development. Incorporating the RainXchange™ System as a Best Management Practice (BMP) provides a more efficient use of land than traditional stormwater retention and detention ponds. The use of the RainXchange™ System can result in more lots available for development and a unique solution that is a functional and attractive way to manage stormwater.

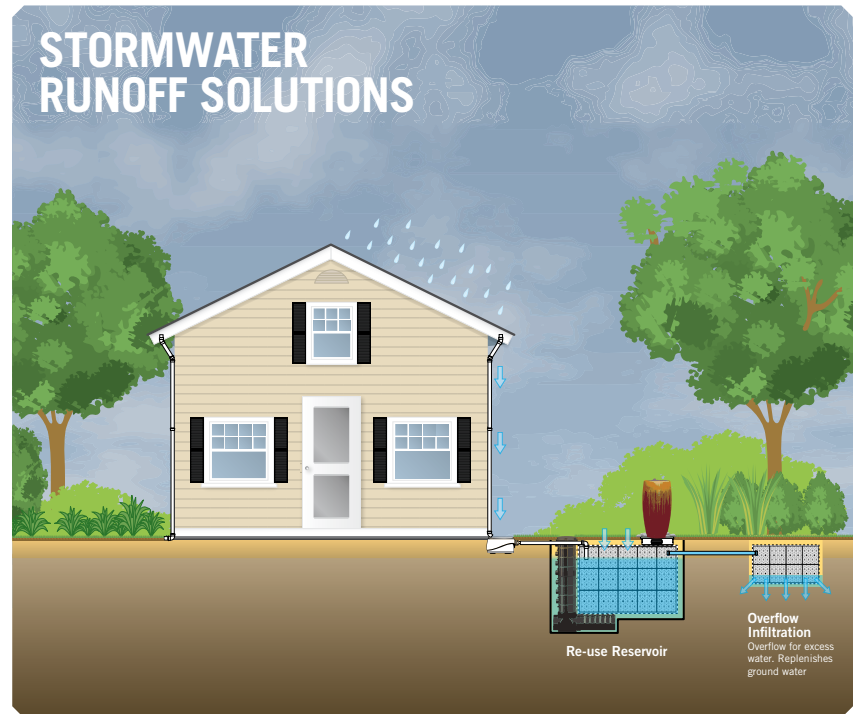

TRANSFORM WASTED STORMWATER RETENTION LAND INTO DEVELOPABLE PROPERTY

- Utilizing the RainXchange™ System as a point source stormwater solution reduces the size of traditional retention basins and may even completely eliminate the need for them.
- This allows for more buildable lots.
- Professionally installed landscape features increase property values.
- The RainXchange™ System can be retrofitted into existing construction to solve drainage issues and relieve over-taxed stormwater systems.

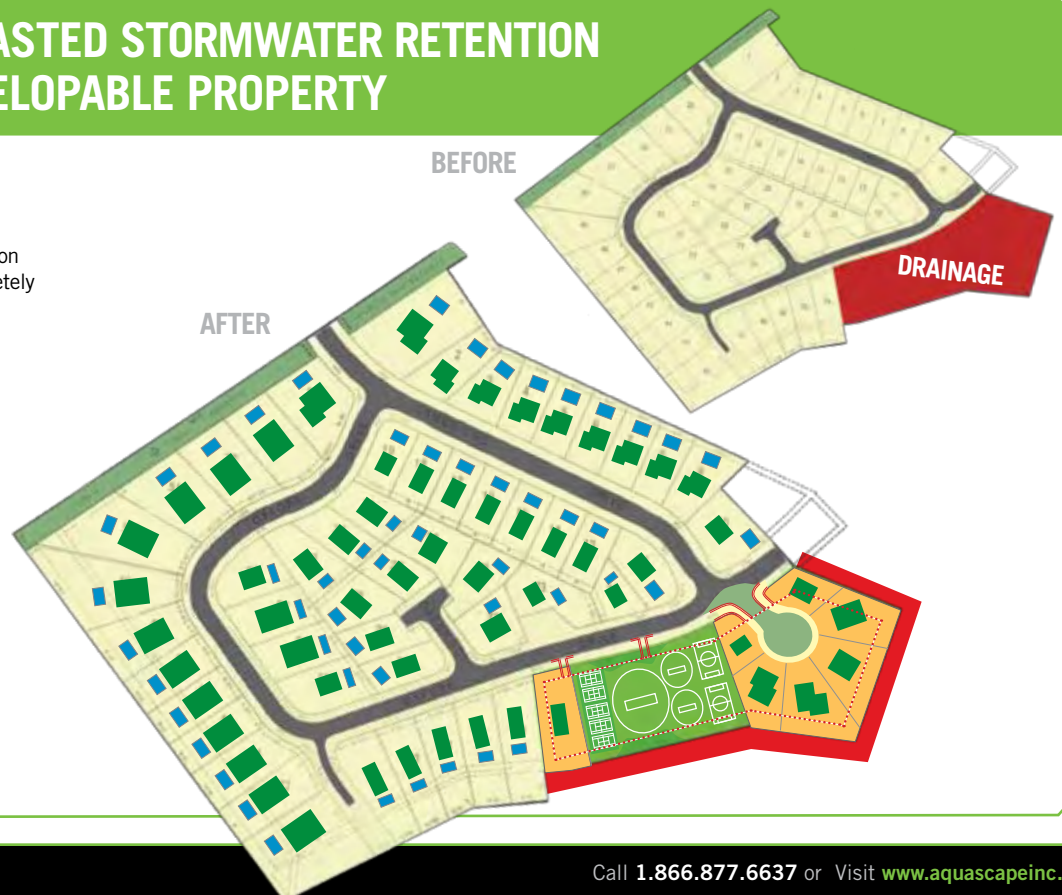

LEED CREDITS FOR AQUASCAPE'S RAINXCHANGE™ SYSTEM



Earn LEED™ credits when you use the RainXchange™ System on your next green building project

SUSTAINABLE SITES (UP TO 4 CREDITS)

By temporarily storing large volumes of water in a small footprint, the RainXchange™ System allows you to maximize open space (credit 5.1) while minimizing the development footprint (credit 5.2). This also reduces the total quantity of stormwater runoff (credit 6.1). Incorporating the RainXchange™ System as part of a bioretention system can also help remove pollutants from runoff (credit 6.2).

- Credit 5.1 – Reduced Site Disturbance, Protect or Restore Open Space
- Credit 5.2 – Reduced Site Disturbance, Development Footprint
- Credit 6.1 – Stormwater Management, Rate or Quantity
- Credit 6.2 – Stormwater Management, Treatment

WATER EFFICIENCY (UP TO 4 CREDITS)

The RainXchange™ System stores rainwater to be used to irrigate the landscaping (credits 1.1 & 1.2), resulting in reduced demand on the building's potable water resources (credits 3.1 & 3.2).

- Credit 1.1 – Water Efficient Landscaping, Reduce by 50%
- Credit 1.2 – Water Efficient Landscaping, No Potable Use or No Irrigation
- Credit 3.1 – Water Use Reduction, 20% Reduction
- Credit 3.2 – Water Use Reduction, 30% Reduction

MATERIALS AND RESOURCES (UP TO 3 CREDITS)

Many of the components of the RainXchange™ System, such as the AquaBlox®, Snorkel® & Centipede® and Downspout Filter are made from recycled plastic and can contribute to the project's recycled content (credits 4.1 & 4.2). The RainXchange™ System can be shipped to the job site fully assembled from a warehouse facility, or can be shipped flat and assembled on site (credit 5.1).

- Credit 4.1 – Recycled Content, Specify 25%
- Credit 4.2 – Recycled Content, Specify 50%
- Credit 5.1 – Local/Regional Materials, 20% Manufactured Locally

INNOVATION AND DESIGN PROCESS (UP TO 1 CREDIT)

There are many ways to incorporate the RainXchange™ System into the design of a green building.

- Credit 1.3 – Innovation in Design: Specific Title

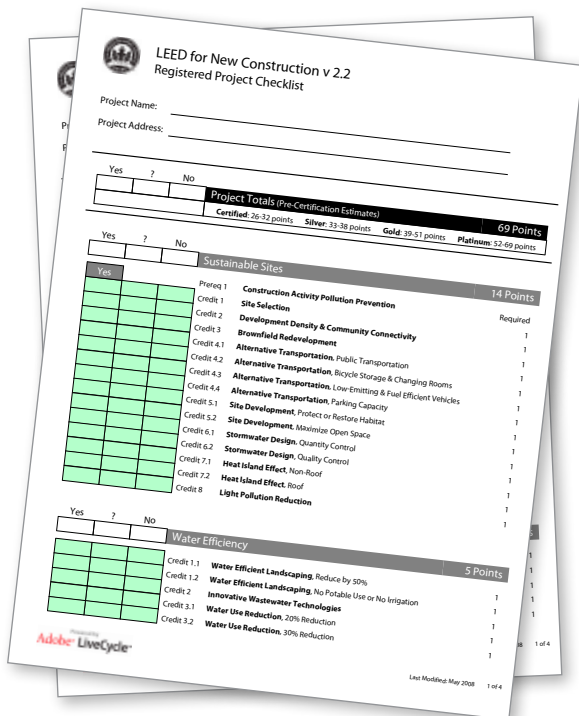

THE RAINXCHANGE™ SPECIFICATION CALCULATOR

Aquascape's RainXchange™ calculator walks you through the project requirements and let's you know what the application requires.

- Tells you what size RainXchange™ System the project will require
- Calculates how much water is generated during a rain storm
- Includes 30-year average rainfall data for your region
- Demonstrates numerous scenarios:
 - The effect of adding or removing Downspout Filters
 - Water requirements based on different irrigation square footage
 - The impact of different storage basin sizes on overall water savings annually

NEED HELP WITH YOUR DESIGN?

CONTACT AQUASCAPE'S TECHNICAL SERVICE

We'll take the guesswork out of estimating your project!

Ph: 1.877.766.3489 (U.S.)
or 1.866.766.3426 (CAN)

Fax: 1.877.329.2348 (U.S.)
or 1.905.454.7310 (CAN)

E-mail: tech@aquascapeinc.com

VISIT www.rainxchange.com/calculator.php

to utilize our online product specification calculator.



AQUABLOX® (D-RAINTANK®)*

Total Stormwater Management

The AquaBlox® modular stormwater systems, also known as the D-Raintank® by Atlantis®, use underground storage and infiltration techniques, resulting in clean water that can be reused or allowed to re-enter the natural water system. The lightweight modular design of the AquaBlox® make installation quicker, safer, and cheaper than traditional options. The AquaBlox® modular systems offer a highly efficient solution for stormwater management.

PRODUCT FEATURES

- **High Capacity** – 95% void space maximizes water storage.
- **Modular** – Easily create any shape and size reservoir to meet the project's requirements.
- **Preserve Valuable Space** – The tanks are installed underground, preserving the appearance and functional use of the land above.
- **Strong Structural Design** – Designed for car loadings up to 5,472 lbs./sq.ft. (38 psi)
- **Easy to Transport** – The tanks are efficiently shipped as unassembled panels, thereby reducing shipping cost.
- **Lightweight and Quick to Install** – No need for cranes or heavy lifting equipment! Assembled and installed by hand.

Modular Design

The lightweight design of AquaBlox® make installation quicker, safer and cheaper.

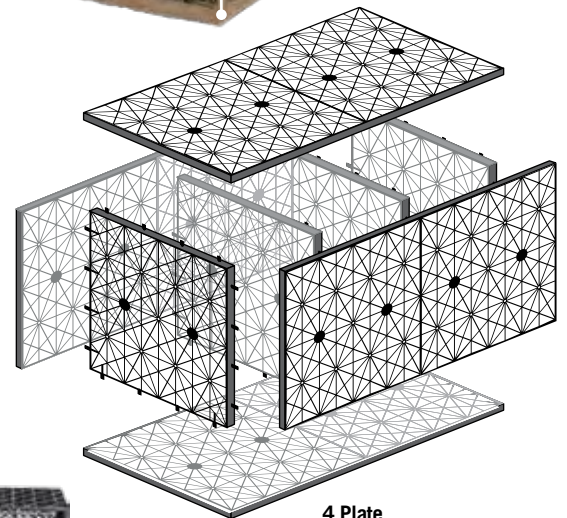

4 Plate

Ultimate Crush Strength:
38.09PSI (26.78t/m²)

Specified Load:
>22.08PSI (15.52t/m²)

Suitable for heavy
duty applications

For more detailed information on the AquaBlox® visit:

VISIT

www.rainxchange.com/products/aquablox.php

Product #	AquaBlox®	Dimensions	Volume	Weight	Load Bearing Weight
29491	Small	26.5"L x 16"W x 9.5"H	17 Gallon	10.35 lbs.	38 psi (Installed)
29492	Large	26.5"L x 16"W x 17.5"H	32 Gallon	15.4 lbs.	38 psi (Installed)

*D-Raintank® is a registered trademark of Atlantis® Water Management Systems

AQUABLOX® SPECIFICATIONS

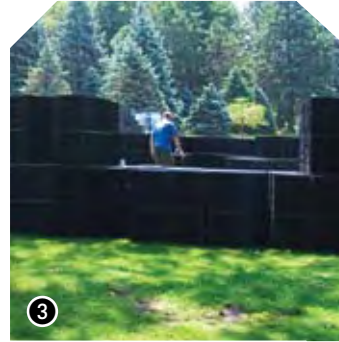

AFTER

A 20' x 60' underground reservoir located at the base of the incoming stormwater flow contains 900 AquaBlox®, which holds over 35,000 gallons of water

1. Clean free draining sand is added as a base.
2. Geotextile underlayment and waterproof membrane are positioned in the reservoir.
- 3&4. AquaBlox® being assembled and installed into reservoir.
5. Aggregate being set on top of AquaBlox®.

AquaBlox® Dimensions

Module (Units)	Height (mm)	Height (inches)	Water Storage Volume (cf / m³)	Water Storage Volume (gal / liters)	Number of Plates Standard Module Large / Small	Tank Weight (lbs / kg)
Small	240	9.45	2.28 / 0.06	17.06 / 64.58	2 / 2 / 4	8.75 / 3.97
Large Single Stack (1)	450	17.72	4.22 / 0.12	31.56 / 119.47	4 / 4	13.97 / 6.34
Large Double Stack (2)	880	34.65	8.25 / 0.23	61.72 / 233.64	7 / 8	25.99 / 11.79
Large Triple Stack (3)	1310	51.57	12.28 / 0.35	91.88 / 347.80	10 / 12	38 / 17.24
Large Quad Stack (4)	1740	68.50	16.31 / 0.46	122.03 / 461.93	13 / 16	50 / 22.68
Large Penta Stack (5)	2170	85.43	20.35 / 0.58	152.19 / 576.10	16 / 20	62 / 28.12

Material Specifications

Surface Area	95% void
Material	85% recycled Polypropylene + 15% proprietary selected materials
Biological & Chemical Resistance	Unaffected by molds and algae, soil-borne chemicals, bacteria and bitumen.

Ultimate Load / Unconfined Crush Testing:

	Imperial	Metric
Crush Load	34 psi	24 t/m²
Displacement	0.433"	11 mm

SNORKEL® VAULT AND CENTIPEDE® MODULE

Our patented Snorkel® Vault and Centipede® Module are modular allowing the builders and designers the flexibility to expand the system to meet their projects requirements.

FEATURES AND BENEFITS

- **Snorkel® Vault and Centipede® Module** positioned at the bottom of water storage basin providing maximum water capacity
- **Highly-effective** at settling out sediment (suspended solids) from the water
- **Decreases maintenance** by reducing the chance of clogged pumps and plumbing
- **Vault lid** provides easy access for reservoir and pumping system inspection, as well as access for cleaning
- **The Snorkel® and Centipedes® modular design** allows it to be constructed in a number of shapes and sizes



U.S. Patent 6,740,232 and 7,114,668

SNORKEL® VAULT & CENTIPEDE® MODULE

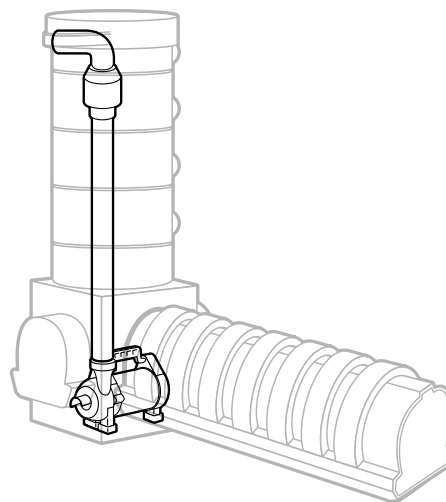

The Snorkel® Vault provides access for inspection and maintenance, yet is easily hidden into the landscape preserving the appearance of the project.

Product #	Product Name	Unit Weight
29064	Snorkel® Vault & Cap	27 lbs.
29238	Half Centipede® Module with Endcap	13 lbs.
29068	Snorkel® Vault Extension*	10 lbs.

* Snorkel® Vault Extension – Extends the height of the Snorkel® Vault when creating deeper water storage basins. Required when stacking 2 or more layers of AquaBlox®.

DOWNSPOUT FILTER

A successful rainwater harvesting project relies on properly pre-filtering the rainwater before it enters the storage reservoir.

- **First Stage in Properly Filtering Rainwater –**
The Downspout Filter is installed at the base of the downspout ready to capture and remove a variety of pollutants that may be flushed into the system during a rain event. Incoming rainwater is passed through a series of mechanical filters that remove leaves, twigs, seeds, and small sediment that accumulate on the surface of the roof between rain events.
- Utilize our **RainXchange™ Calculator** to determine how many Downspout Filters your project will require. **See page 9 for more details.**
- Handles up to a **1,500 sq. ft. roof** and more than 50 gallons per minute flow rate.

DOWNSPOUT FILTER IN USE:



Grated lid and layer of gravel removes large debris, such as leaves and twigs.

Smaller particulates are captured in a 300 micron, easy to clean debris net.

Molded hose-tail stub fits 3" or 4" drain pipe.



Durable rotation-ally-molded unit withstands freeze/thaw conditions.

Small percolation holes at the bottom of the filter allow water remaining after a rain event to slowly percolate out of Downspout Filter preventing stagnant mosquito-harboring water from accumulating in the filter between rain events.

Catalog Code	Product Description	Unit Weight
30166	Downspout Filter	10 lbs.
30095	Replacement Debris Net for Downspout Filter	.25 lbs.

Aquascape's Downspout Filter is buried out of sight at the base of the downspout.

WATER SUPPLY PRODUCTS

The RainXchange™ System is an ideal partner for a wide range of irrigation solutions. From basic hand-watering through a garden hose or using it in combination with a professionally designed irrigation system, the flexibility of the RainXchange™ System provides a sustainable water supply solution that will meet the requirements of your next project.

Aquascape offers several pump and plumbing options for general hand-watering and basic irrigation applications. We recommend consulting with Aquascape's Technical Service Department or a professional irrigation designer to determine the irrigation options that are best suited for your project.

RAINXCHANGE™ WATER MAKE-UP SYSTEM

A simple solution for adding tap-water into the RainXchange™ basin during low water levels ensuring a continuous supply of water. Can be attached to an outdoor spigot or professionally plumbed into a water supply line. This design meets local codes for high hazard connections by utilizing an air-gap to direct municipal make-up water through the water storage basin. Includes: Water Feed Float Switch (also sold separately), Irrigation Valve, 24-volt low-voltage transformer and low-voltage cable. Plumbing not included.



WATER FEED FLOAT SWITCH

Specially designed doser-style float switch signals an irrigation valve to open and add tap water during low water levels in the RainXchange™ storage basin. Located in the lower portion of the Snorkel® Vault. Requires irrigation valve, transformer, and plumbing.



LOW WATER PUMP SHUT OFF

An optional shut-off switch that can be used to turn the Booster Pump off in low water level situations. Recommended when not using the Water Make-up System or Water Feed Float Switch. The Switch is located in the Snorkel® Vault. Includes an 18 ft cord and works with pumps up to 10 amps.



BOOSTER PUMPS

A simple pumping solution that provides access to the water for general hand-watering and basic irrigation.

- The Booster Pump is designed to increase the water pressure for basic irrigation.
- Booster Pumps are external, non-submerged pumps.
- The Booster Pump fitting kit includes pipe and a number of fittings to plumb the system for basic irrigation supply.



Booster Pump

Booster Pump Plumbing Kit



Catalog Code	Product Description	Unit Weight
30084	Booster Pump ¼ HP	16.3 lbs.
30085	Booster Pump ½ HP	19.6 lbs.
30094	Pondless® Booster Fitting Kit	6 lbs.
30170	Decorative Booster Fitting Kit	6 lbs.

Model	Power (HP)	Cycle (Hz)	Phase (Ø)	Voltage (V)	Amps (A)	Inlet (NPT)	Outlet (NPT)	H max. (ft)	Q max. (GPM)
Booster Pump ¼ HP	¼	60	1	115 or 230	4.0 or 2.0	1"	1"	72	16.9
Booster Pump ½ HP	½	60	1	115 or 230	6.0 or 3.0	1"	1"	90	18.5

Note: The Booster Pump, Booster Pump plumbing kit, and Low Water Pump Shut Off are sold separately from the RainXchange™ Systems.

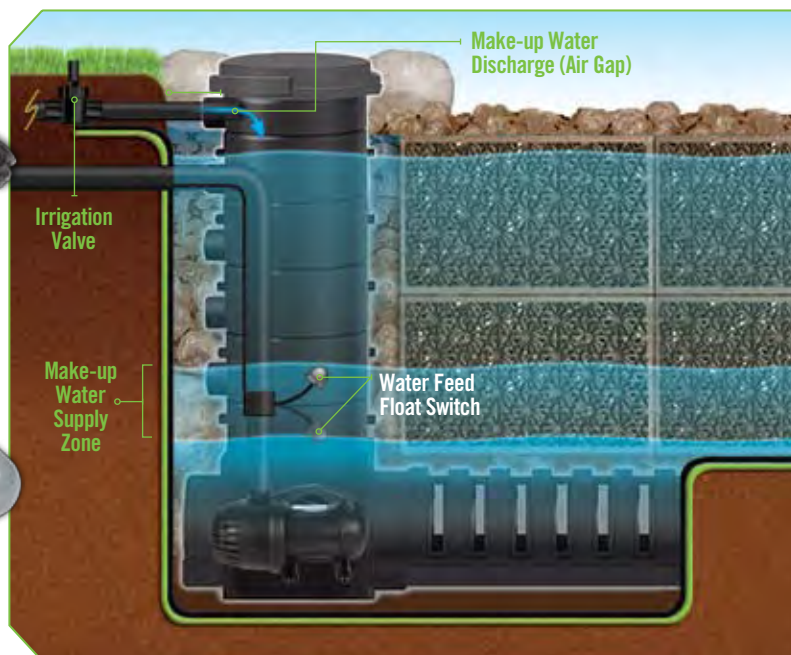

Product #	Product Name	Unit Weight
30390	Water Make-up System	3.55 lbs
30386	Water Feed Float Switch	1.2 lbs.
29647	Low Water Pump Shut Off Unit	1.7 lbs.

LINER AND GEOTEXTILE

A successful project starts with a good foundation. Aquascape's liner and geotextiles have been field-tested and field-proven by our design-build firm for the past 19 years. There are a variety of product types and sizes available to meet the requirements of your application.

WATERPROOF LINER

45 MIL EPDM Liner

EPDM liner is flexible making installation remarkably efficient when compared to traditional construction materials, such as concrete, plastic and fiberglass. The EPDM membrane is very durable and carries a 20 year manufacturer warranty.

- Available in full roll lengths of 50 ft. and 100 ft.
- Also available in customized, cut-to-size lengths. Minimum liner size is 10 ft. x 10 ft. – larger sizes cut in 5 ft. increments
- Unit weight is .3 lbs per sq.ft.



Standard* Roll Width (ft)

10 x 50 or 100
15 x 50 or 100
20 x 50 or 100
25 x 50 or 100
30 x 50 or 100
35 x 50 or 100
40 x 50 or 100
45 x 50 or 100
50 x 50 or 100

* Larger roll lengths of 150' and 200' available. Call for availability!

GEOTEXTILES

Geotextile Underlayment

This soft, polyethylene fabric will last 20+ years under the liner. It is a 3-dimensional underlayment that allows gas and vapors to escape. It has a non-slippery surface and provides protection for the liner from rocks and other sharp objects, and spreads easily. We recommend sandwiching the liner between an outer and inner layer of geotextile for maximum strength and liner protection. This is a non-woven, needle-punched 4.5 oz. per sq.yd² geotextile. Because of the nature of customized features (unique designs, large boulders and tough site conditions) heavy duty underlayment may be recommended. This non-woven, needle-punched 16 oz. per sq.yd² geotextile is four times the thickness of our standard underlayment.

Catalog Code	Product Description	Unit Weight
29227	Underlayment Cut to Size	.04 lbs./sq. ft.
29169	15 ft. x 300 ft. Underlayment Roll	200 lbs.
29170	7.5 ft. x 600 ft. Underlayment Roll	200 lbs.
25001	15 ft. x 150 ft. Heavy Duty Underlayment Roll	260 lbs.
25000	3 ft. x 3 ft. Heavy Duty Underlayment Pad	1.1 lbs.

DETAIL VIEW

- Fountain
- Rocks
- Permeable Pavers
- Bed Aggregate Layers
- Woven Geotextile over storage basin
- AquaBlox®
- Inner Underlayment
- Waterproof Liner
- Protective Sand Layer
- Outer Underlayment
- Soil

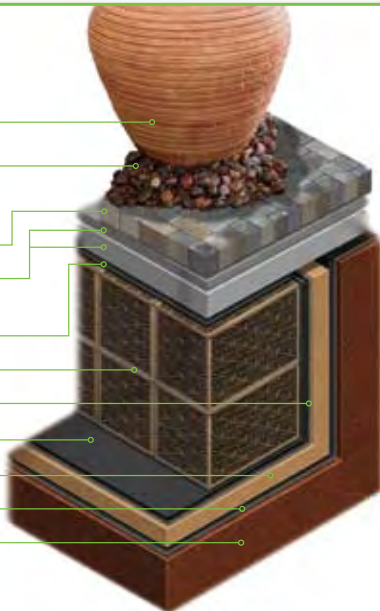

Diagram demonstrates cross-section of permeable paver application. **Note:** woven geotextile required on top of AquaBlox® for permeable paver applications to support bedding aggregate.

Woven Geotextile

A specialty woven geotextile recommended for use on top of the AquaBlox® when using permeable pavers. This woven geotextile keeps the base aggregate bed on top of the AquaBlox® while allowing water to infiltrate into the water storage basin.

Catalog Code	Product Description	Unit Weight
30219	Woven Geotextile Cut to Size	.04 lbs./sq. ft.
30220	12.5 ft. x 10 ft. Woven Geotextile	5 lbs.



RainXchange™ SYSTEMS

With our easy-to-use, prepackaged RainXchange™ System Kits, you have the flexibility to choose the water storage size and decorative style that suits you! Simply follow the step-by-step selection chart to determine the products required to complete your RainXchange™ System.

STEP 1 CHOOSE THE RAINXCHANGE™ SYSTEM WATER STORAGE KIT.

RainXchange™ Water Storage Kits

Each RainXchange™ Water Storage Kit Includes: AquaBlox®, 45 mil EPDM rubber liner membrane, and two panels of non-woven geotextile underlayment (one to surround the AquaBlox® and one to surround the exterior of the EPDM rubber liner).



500 Gallon Water Storage Kit Catalog #30097

- Basin Size: 6'x9'x4'
- 16 AquaBlox®
- 15'x 20' Liner and Underlayment

1000 Gallon Water Storage Kit Catalog #30099

- Basin Size: 6'x9'x5'
- 32 AquaBlox®
- 20'x 25' Liner and Underlayment
- Snorkel® Vault Extension

1500 Gallon Water Storage Kit Catalog #30102

- Basin Size: 8'x9'x5'
- 48 AquaBlox®
- 25'x 25' Liner and Underlayment
- Snorkel® Vault Extension

2000 Gallon Water Storage Kit Catalog #30105

- Basin Size: 9'x11'x5'
- 64 AquaBlox®
- 25'x 30' Liner and Underlayment
- Snorkel® Vault Extension

2500 Gallon Water Storage Kit Catalog #30108

- Basin Size: 11'x12'x5'
- 80 AquaBlox®
- 25'x 30' Liner and Underlayment
- Snorkel® Vault Extension

3000 Gallon Water Storage Kit Catalog #30112

- Basin Size: 9'x11'x6'
- 96 AquaBlox®
- 25'x 30' Liner and Underlayment
- Snorkel® Vault Extension

STEP 2 CHOOSE YOUR WATER FEATURE.

Decorative Fountains

Select from a number of decorative bubbling urns and stone fountains that sit on top of the RainXchange™ Water Storage System. The water spills over the top of the decorative piece and flows back down into the RainXchange™ Water Storage System where it is re-circulated.



Decorative Fountain Pump

and Vault Components Catalog #30173

- Snorkel® Vault and Centipede® Module
- One Downspout Filter (additional units may be purchased separately)
- AquaSurge™ 2000 High Efficiency Pump
- Decorative Fountain Plumbing Kit (includes assortment of fittings and 3/4" x 25' Kink-Free Pipe)



Pondless® Waterfall

This water feature is made up of a waterfall or stream that flows and then disappears gracefully into the gravel.

Please note: Determine the desired length of stream and waterfall, then choose the appropriate stream liner found on the next page.



Pondless® Waterfall Pump

and Vault Components Catalog #30098

- Snorkel® Vault and Centipede® Module
- One Downspout Filter (additional units may be purchased separately)
- AquaSurge™ 4000 High Efficiency Pump
- Pondless® Waterfall Plumbing Kit

NEED HELP WITH YOUR DESIGN?

Utilize the RainXchange™ Specification Calculator at www.rainxchange.com to determine the water storage requirements for your project or call our Technical Department at 877.766.3489 (U.S.) or 1.866.766.3426 (CAN) and let one of our Technical Agents help you estimate your next project.

STEP 3 CHOOSE THE DECORATIVE FOUNTAIN OR PONDLESS® WATERFALL FILTER

Tan/Black Ceramic Angled Top Urn

Catalog #98470

- 18" Dia. x 35" H
- Unit Weight 64 lbs.



Natural Mongolian Basalt Column

Catalog #98503

- 12" Dia. x 30" H
- Unit Weight 330 lbs.



Pouring Stone Roman Vase

Catalog #98550

- 20" Dia. x 19" H
- Unit Weight 295 lbs.



Blue Vertical Grooved Ceramic Pot

Catalog #98479

- 22" Dia. x 23" H
- Unit Weight 90 lbs.



Cascading Twisted Stone Water Column Fountain

Catalog #98547

- 12" L x 12" W x 30" H
- Unit Weight 228 lbs.

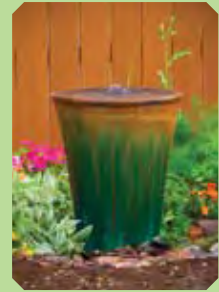

Tan/Green Ceramic V-Shaped Urn

Catalog #98477

- 23" Dia. x 26" H
- Unit Weight 66 lbs.

For a wider selection of Aquascape's Decorative Fountains please refer to the Aquascape Product Catalog

**Pondless® Waterfall Filter Components**

Catalog #30383

- Signature Series™ BioFalls® Filter 2500
- 2x 12 Volt 1-Watt LED Waterfall Lights
- 1x 12 Volt 60-Watt Transformer
- 2" x 25' Flexible PVC water pipe

**ADD-ON STREAM LINERS**

Box Contents: 10' wide by 10', 20' or 30' long stream liner (not included in any box listed above)

(NOTE: when adding stream, additional pipe and coupling may be needed)

- | | | |
|----------------|--------------------|---------|
| Catalog #29607 | Stream Liner 10x10 | 29 lbs. |
| Catalog #29612 | Stream Liner 10x20 | 58 lbs. |
| Catalog #29616 | Stream Liner 10x30 | 87 lbs. |

INFORMATION AND MARKETING MATERIALS

RAINXCHANGE™ RESIDENTIAL SALES BROCHURE

This full-color, 4-page brochure is designed to provide residential clients with an understanding of why it is important to capture and reuse rainwater and demonstrates the difference of Aquascape's unique RainXchange™ System compared to traditional rainwater harvesting options. The included cross-section is a useful tool to help explain the working components of the RainXchange™ System. Photos of installed systems demonstrate how the RainXchange™ System is not only a functional rainwater harvesting system, but an attractive water feature that the homeowners can enjoy. Includes a location on the back cover where you can stamp or sticker with your company information.



NEW! RAINXCHANGE™ SUSTAINABLE WATER MANAGEMENT SOLUTIONS BROCHURE

A fold-out brochure designed to introduce the RainXchange™ System to architects, developers, engineers, government agencies and other professional-based audiences. A two-page, full-color cross-section is a useful tool to help explain the working components of the RainXchange™ System. Photos of installed systems are also included to demonstrate how the RainXchange™ System is not only functional, but an attractive design component to any project. Includes a location on the back cover where you can stamp or sticker with your company information.

For clients requiring a more in-depth look at the RainXchange™ System and related products we recommend the 20-page RainXchange™ Solutions Guide.



NEW! 2010 RAINXCHANGE™ PRODUCT AND APPLICATION GUIDE

A thorough 20-page guide provides product and technical information on the RainXchange™ System. A two-page, full-color cross section helps explain the working components of the RainXchange™ System and is followed by pages containing information on each of the products associated with RainXchange™ System. The Solutions Guide can be used as a reference when designing RainXchange™ projects or as a marketing piece for the more technically-minded clients. Includes a location on the back cover where you can stamp or sticker with your company information.



RAINXCHANGE™ BANNER

This 6 ft. w x 4 ft. h banner illustrates how the RainXchange™ System works below and above the surface. Ideal for tradeshow/home-show promotions. Durable vinyl material.



Product #	Product Name	Qty.	Unit Weight
30168	RainXchange™ Residential Sales Brochure	50 pack	2 lbs.
30371	RainXchange™ Sustainable Water Management Solutions Brochure	100 pack	2 lbs.
30169	2010 RainXchange™ Product and Applications Guide	25 pack	3.2 lbs.
30167	RainXchange™ Banner	1	2.2 lbs.

BECOME A CERTIFIED RainXchange™ PROFESSIONAL

BENEFITS

- **Receive exposure** on Aquascape's website allowing potential customers to find you for future installation projects.
- **Provides credibility** to the public that you are conscious about the needs of our environment and are educated on rainwater harvesting.
- **Enjoy exclusive rights** to use the Certified RainXchange™ Professional logo in any of your marketing materials.

CRITERIA

Complete either one of the following to become a Certified RainXchange™ Professional:

- Online Training
- Attend one of Aquascape's RainXchange™ Seminar/Build
- Complete and Pass RainXchange™ Test



VISIT www.rainxchange.com and click the "Certification" Link



DISCOVER THE BEAUTY OF RAINWATER HARVESTING

Who says it has to be an eyesore?

The RainXchange™ Rain Barrel has a planter lid for flowers and the water harvested is healthier for your plants.

FEATURES

- LARGE 75-gallon capacity!
- 5-year warranty
- Requires no electricity
- Large safety overflow keeps water in the barrel or away from the house
- Lid can also be used as a planter
- Thick plastic walls are durable and will withstand extreme conditions
- Childproof lockable lid
- Brass spigot for garden hose connection
- Made in the U.S.A.

BENEFITS

- **It's SIMPLE.** The RainXchange™ Rain Barrel can be incorporated into existing gutter and drainage systems.
- **It's RESPONSIBLE.** Water restrictions do not apply to rain barrels. Storing rain water allows you to keep gardens growing during watering restrictions and reduces the burden for municipal water.
- **It's BENEFICIAL.** Rainwater is better for plants than municipally treated water.



The RainXchange™ Rain Barrel can be incorporated into existing gutter and drainage systems.



Integrated planter helps naturalize the Rain Barrel into the landscape design.

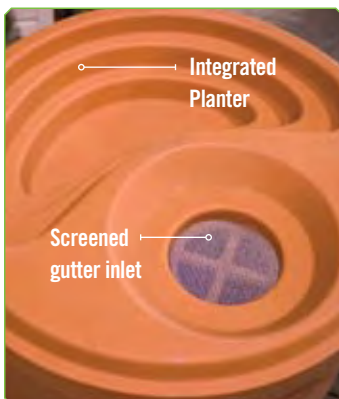

Available in Sandstone (right) or Terra Cotta (below)



Internally designed overflow keeps plumbing out of sight

Catalog Code	Product Description	Unit Weight
98766	RainXchange™ Rain Barrel 40" h x 29" w (Terra Cotta)	30 lbs.
98767	RainXchange™ Rain Barrel 40" h x 29" w (Sandstone)	30 lbs.

RAINWATER HARVEST SYSTEMS SOLUTIONS GUIDE

Aquascape's ecosystem approach to water gardening is based on recreating a naturally functioning ecosystem. Water circulation, filtration, fish, plants, rocks and beneficial bacteria are all used to ensure a balanced system and long term sustainability.

Aquascape is committed to further expand its environmental position by developing innovative new products with a focus on the environment and the long term sustainability of the world's most precious resource, water.

The RainXchangeTM System offers companies, as well as consumers the opportunity to do their part to address some of the challenges associated with drought and the increasing problem of excessive stormwater run-off.

To learn more about Aquascape as a company and our initiatives please log onto our website at www.aquascapeinc.com.



For more information on the RainXchangeTM System,

VISIT www.rainxchange.com



U.S. 901 Aqualand Way • St. Charles, IL 60174
Toll Free: (866) US-PONDS or (866) 877-6637
Customer Service Fax: (877) 329-2340
Technical Support Fax: (877) 329-2348

CAN 100 West Creek • Brampton, ON, L6T 5V7
Toll Free: (866) POND-H2O or (866) 766.3426
Customer Service Fax: (905) 454-7310
Technical Support Fax: (905) 454-7310